

# XL30/XL25/SL25

COLORVIEW™ PROJECTORS



Only 27 dBA!

MEANT TO BE SEEN,  
NOT TO BE HEARD

MITSUBISHI'S SILENT SERIES™

 **MITSUBISHI  
ELECTRIC**  
PRESENTATION PRODUCTS  
**REVOLUTIONIZINGCOLOR™**

**ColorView**  
NATURAL COLOR MATRIX™

**sRGB**

3000 ANSI LUMENS  
(XL30)

13 POUNDS

SILENT SERIES™  
PROJECTORS (27 DBA)

PICTURE-IN-PICTURE

DIGITAL KEYSTONE  
ADJUSTMENT

INTELLIGENT ROOM  
ILLUMINATION SENSOR  
(IRIS®)

PROGRAMMABLE  
UNIVERSAL REMOTE

EASY SLIDE-ACCESS  
DISPOSABLE FILTER

USER-DEFINABLE MUTE  
AND LOGO SCREEN

The XL30, XL25, and SL25 ColorView projectors from Mitsubishi are the quietest, low-noise projectors in the world today at 27 dBA during lamp conservation mode. Mitsubishi's Silent Series™ projectors allow the audience to enjoy presentations without distraction. In addition to low noise they also offer increased brightness and improved video. Brighten up any presentation with Mitsubishi's high performance, ultra-quiet XL30, XL25, and SL25 ColorView projectors.

- Exclusive, award-winning ColorView Natural Color Matrix for rich, vivid colors.
- sRGB color profile technology ensures standard uniform color reproduction regardless of the type of display used.
- 3D CineView™, Mitsubishi's proprietary video technology, significantly reduces flickering, artifacts, crawling, or blinking, with the image as sharp and smooth as its native film format.
- Fully compatible with Mitsubishi's ProjectorView™ Networking system which enables a company's designated administrator and authorized users to remotely control, monitor, manage, and even diagnose a Mitsubishi projector.
- Three-year parts and labor warranty and 90-day warranty on the lamp (both warranties available in U.S. and Canada), toll-free technical support, plus an Express Replacement Assistance (ERA) program (three-years XL30/XL25; two years SL25) that guarantees free replacement product shipped overnight for next business day delivery when and where available.

Designed for  
  
Microsoft  
Windows NT  
Windows 98

  
Mac

  
ISO  
9001  
QUALITY  
ASSURANCE

  
3  
YEAR  
WARRANTY

  
EXPRESS REPLACEMENT  
ASSISTANCE  
E.R.A.

# Make impressive presentations full of impact with these feature-loaded, super-quiet projectors that shine bright and sharp.

Compact yet offering outstanding picture brightness of 3000 ANSI Lumens (XL30U) thanks to the new 0.99-inch LCD panel, these stylishly designed projectors are fully equipped for user-friendly operation and easy maintenance. Ultra-quiet operation – only 27 dBA in Lamp Low mode – significantly reduces noise level to allow the audience to better concentrate on the presentation. These models also feature a programmable universal remote controller that can be programmed to control DVD players and video recorders connected to the projector. Other beneficial features such as a disposable rear-access filter that helps to ease servicing, plus 10 language OSD and 5 BNC terminals make these multimedia data/video projectors the smart choice for adding a professional touch to any presentation.

## 0.99-inch LCD Panel (3000 ANSI Lumens)

Compact in size yet big on performance, the XL30U incorporates a 0.99-inch LCD panel that allows for picture brightness of 3000 ANSI Lumens, more than enough to ensure clear, sharp images even in well-lit conference rooms or halls.



## sRGB

Developed to ensure standard, uniform color reproduction regardless of the type of display used, sRGB color profile technology uses independent color coordinates common to all display technologies. As a result, it helps to eliminate hue variations that occur between different display systems and more accurately matches the way colors look in real life.

To find out the details of sRGB, visit us at [www.mitsubishi-presentations.com](http://www.mitsubishi-presentations.com)



## World's Quietest Projector... Only 27 dBA

Fan noise emanating from a projector can get annoying during a presentation but now that's a thing of the past. The XL30U offers ultra-quiet operation of only 27dBA (in Lamp Low mode) thanks to technological refinements such as the newly designed fan that is positioned in front of the projector. This means that the audience can enjoy presentations without distraction.

**XL30U XGA**

**XGA / 3000 ANSI Lumens**



# Impressive Picture Quality

## 3D CineView

Surpassing the performance of the previous Line Doubler function, 3D CineView realizes improved cross coloring and virtually eliminates the "jaggies" for clearer still images with crisp contours. It is also useful for text such as subtitles as characters are sharper and easier to read. Along with the reproduction of beautiful, natural-looking moving images, a significant gain in video picture quality has been achieved, making it possible to recreate images with cinema-like presence.



Without 3D CineView



With 3D CineView

## Natural Color Matrix™

Equipped with the third generation of Mitsubishi Electric's Natural Color Matrix™, these projector models provide vivid and accurate color reproduction that helps to add realism and appeal to any presentation. This feature now offers TINT adjustment for PC screens in addition to its 6-axis color correction function, providing precise and easy adjustment of both color saturation and tone for exquisite image quality.



Without Natural Color Matrix™



With Natural Color Matrix™

## IRIS® (Intelligent Room Illumination Sensor)

The level of room illumination has a significant effect on the quality and accuracy of on-screen color reproduction because the screen brightens as the room gets brighter and colors will appear dull. These multimedia data/video projectors offer a built-in IRIS that automatically detects illumination level and color density, adjusting mid-range color tones as required for optimal color reproduction and clear images under any lighting condition such as when the curtains are opened or the lights are dimmed.



Change in interior illumination brightens the room.



With IRIS Automatic contrast adjustment for a clearer picture.



Without IRIS Bright interior illumination dulls color and the image.

# Technological Features

## 2 Live Picture-In-Picture (Real Motion)

This Mitsubishi Electric original technology allows you to show two images (two motion/live images) simultaneously on screen. For example, images from two different sources (PC and video) can be shown at the same time on the main screen and PIP to provide the audience with more visual information, doubling the impact of any presentation and making it ideal for video conferencing. An increase in video processing to 60 frames/sec. provides smoother image transitions and it is also possible to zoom up on the picture.

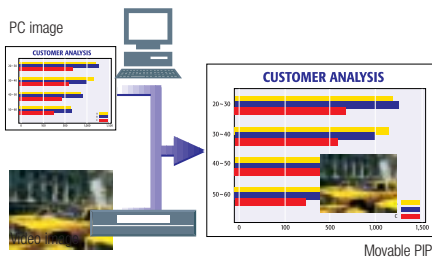

## Digital-Expanded Zoom

Presentations become more professional and stimulating as Mitsubishi's Digital-Expanded Zoom makes it easy to explain and clearly see the details. Variable digital enlargement allows a section of an image to be magnified conveniently, making it ideal for use during lectures, meetings, etc.

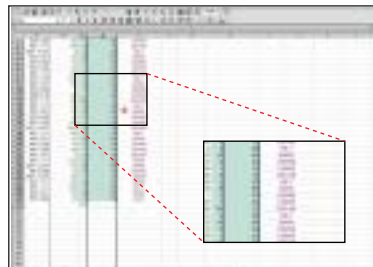

A red cross indicates the area expanded and displayed in the PIP on screen.

## Digital Keystone Adjustment

Absolutely essential for portable projectors, Digital Keystone Adjustment reduces line distortion for a more natural picture even when it is difficult to set up the unit perfectly perpendicular with the screen. This important feature allows you to project at an angle up to  $\pm 30^\circ$  without worrying about trapezoid image distortion.

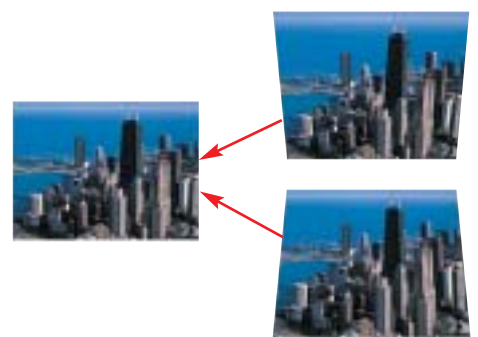

# User-friendly Operation

## Programmable Universal Remote

To further improve operating ease, the Programmable Universal Remote can be programmed to control DVD players and video recorders connected to the projector.

## User Logo Display

Users can customize the projector to their preference by inserting a corporate name, logo or an image of their choice on the Splash or Mute screen.

## 10 Language OSD

The multi-language OSD makes these projectors ideal for international use, as it is capable of displaying 10 different languages including English, French, German, Spanish, Italian, Portuguese, Korean, Russian, Japanese, and Chinese. With this convenient feature, these multimedia data/video projectors are the worldwide choice for any business presentation.

## Versatile Input Terminals

Offering far more operating convenience for system installation, these multimedia data/video projectors are fully equipped with 5 BNC input terminals that allow for a variety of audio-visual and PC peripheral equipment to be connected easily. This kind of versatility is especially welcome when upgrading from a conventional CRT projector or creating a complete system for permanent installation.

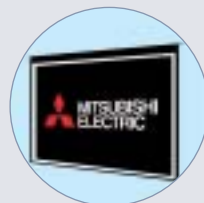
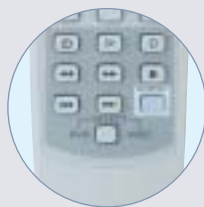

## Easy Slide-Access Disposable Filter

A disposable filter eliminates the need for frequent cleaning and helps to reduce maintenance requirements. However, it is recommended that the filter be cleaned periodically to prolong use. For added convenience, this filter can be easily accessed from the rear without removing the projector from the ceiling mount bracket.

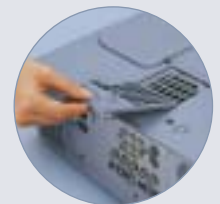

## ProjectorView™ Diagnostic System (optional)

To monitor projectors and facilitate maintenance, the optional ProjectorView diagnostic system provides control over key projector functions such as power on/off as well as warnings for operating temperature and filter clogging. Controlled via a master PC, this system is ideal for incorporating other Mitsubishi projectors into a Local Area Network (LAN) for both academic and business environments.



## Optional Lenses

A wide variety of optional lenses are available to suit any operating or user requirement.

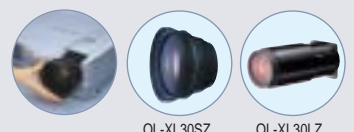

# XL25U XGA/2500 ANSI Lumens

# SL25U SVGA/2600 ANSI Lumens



- sRGB
- 3D CineView
- Natural Color Matrix™
- IRIS (Intelligent Room Illumination Sensor)
- 2 Live Picture-In-Picture (Real Motion)
- Digital-Expanded Zoom
- Digital Keystone Adjustment
- Ultra-Quiet Operation: 27dBA
- Programmable Universal Remote
- User Logo Display
- 10 Language OSD
- Versatile Input Terminals



- sRGB
- 3D CineView
- Natural Color Matrix™
- IRIS (Intelligent Room Illumination Sensor)
- 2 Live Picture-In-Picture (Real Motion)
- Digital-Expanded Zoom
- Digital Keystone Adjustment
- Ultra-Quiet Operation: 27dBA
- Programmable Universal Remote
- User Logo Display
- 10 Language OSD
- Versatile Input Terminals

## Specifications

Models	XL30U	XL25U	SL25U
Display technology	1" Polysilicon panel x 3	1" Polysilicon panel x 3	1" Polysilicon panel x 3
Resolution	1024 x 768 (total 2,359,296 pixels), 540 video lines	1024 x 768 (total 2,359,296 pixels), 540 video lines	800 x 600 (total 1,440,000 pixels), 540 video lines
Brightness	3000 ANSI Lumens	2500 ANSI Lumens	2600 ANSI Lumens
Color	16,770,000 colors	16,770,000 colors	16,770,000 colors
Zoom / focus	Manual control (zoom ratio: 1.3 : 1)	Manual control (zoom ratio: 1.3 : 1)	Manual control (zoom ratio: 1.3 : 1)
Picture size	40" ~ 300" (100"=3.6 m)	40" ~ 300" (100"=3.6 m)	40" ~ 300" (100"=3.6 m)
Source lamp	270W bulb	270W bulb	270W bulb
Computer compatibility	VGA® ~ UXGA® (640 x 400 ~ 1600 x 1200), True: 1024 x 768, Sync on green available	VGA® ~ UXGA® (640 x 400 ~ 1600 x 1200), True: 1024 x 768, Sync on green available	VGA® ~ SXGA® (640 x 400 ~ 1280 x 1024), True: 800 x 600, Sync on green available
Video compatibility	NTSC/NTSC 4.43/PAL (including PAL-M,N)/SECAM/PAL-60/ DVD (component) / HDTV (525p, 720p, 1080i) SCART plug (RGB +1V sync)	NTSC/NTSC 4.43/PAL (including PAL-M,N)/SECAM/PAL-60/ DVD (component) / HDTV (525p, 720p, 1080i) SCART plug (RGB +1V sync)	NTSC/NTSC 4.43/PAL (including PAL-M,N)/SECAM/PAL-60/ DVD (component) / HDTV (525p, 720p, 1080i) SCART plug (RGB +1V sync)
Input terminals	PC: mini D-sub 15 pin x 1, BNC x 5 Video1: RCA + S video x 1, Video2: RCA + BNC x 1 Audio: RCA x 2	PC: mini D-sub 15 pin x 1, BNC x 5 Video1: RCA + S video x 1, Video2: RCA + BNC x 1 Audio: RCA x 2	PC: mini D-sub 15 pin x 1, BNC x 5 Video1: RCA + S video x 1, Video2: RCA + BNC x 1 Audio: RCA x 2
Output terminals	RGB: mini D-sub 15 pin x 1	RGB: mini D-sub 15 pin x 1	RGB: mini D-sub 15 pin x 1
Communication terminals	RS-232C x 1 (DIN 8 pin), mouse terminal for USB	RS-232C x 1 (DIN 8 pin), mouse terminal for USB	RS-232C x 1 (DIN 8 pin), mouse terminal for USB
Audio speaker	3 W	3 W	3 W
Fan noise	27 dBA	27 dBA	27 dBA
Dimensions (W x H x D)	14.9" x 6.2" x 12.1" / 380 x 157 x 307 mm (including lens and feet)	14.9" x 6.2" x 12.1" / 380 x 157 x 307 mm (including lens and feet)	14.9" x 6.2" x 12.1" / 380 x 157 x 307 mm (including lens and feet)
Weight	13 lbs / 5.9 kg	13 lbs / 5.9 kg	13 lbs / 5.9 kg
Power supply	AC100 ~ 240 V / ±10 %, 50/60 Hz	AC100 ~ 240 V / ±10 %, 50/60 Hz	AC100 ~ 240 V / ±10 %, 50/60 Hz

## Input and Output Terminals

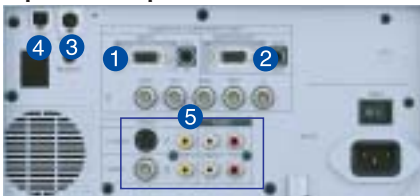

- 1 PC analog RGB input (mini D-SUB 15P)
- 2 PC analog RGB output (mini D-SUB 15P)
- 3 RS-232C input (Din-8P)
- 4 USB input
- 5 Video/audio input



**VLT-XL30LP**  
Optional Lamp



**OL-XL30SZ**  
1.4-1.8  
Optional short throw lens



**OL-XL30LZ**  
2.5-3.5  
Optional long throw lens

## Dimensions (unit: mm, inch)

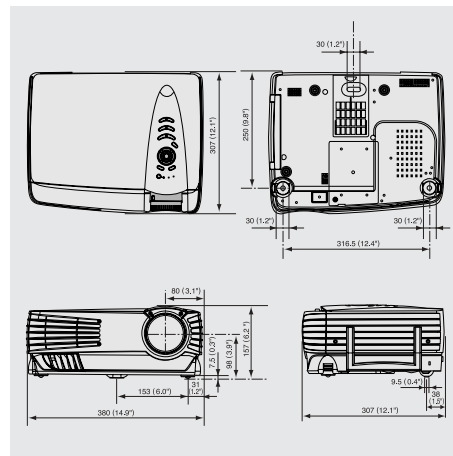

## Projection distance at each screen size

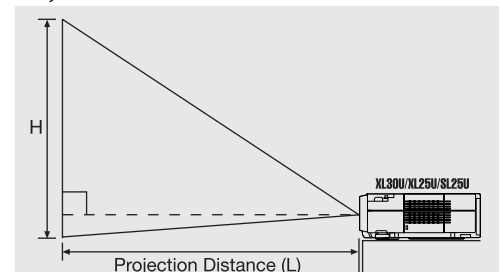

Screen Diagonal size (m)	Screen Diagonal size (inch)	Distance from screen (L)(approximate)		Height projected	
		Maximum zoom (WIDE) (m)	Minimum zoom (TELE) (m)	(cm)	(inch)
1.02	40"	1.4	55"	1.8	71"
1.52	60"	2.1	83"	2.7	106"
2.03	80"	2.9	114"	3.7	146"
2.54	100"	3.6	142"	4.6	181"
3.81	150"	5.5	217"	6.9	272"
5.08	200"	7.3	287"	9.3	366"
6.35	250"	9.2	365"	—	—
7.62	300"	11.0	433"	—	—

\*The above numbers are approximate, and may be slightly different from the actual measurements.

©2002 Mitsubishi Digital Electronics America, Inc. Standard features, options and specifications subject to change without notice. Microsoft, Windows, and the Windows logo are registered trademarks of Microsoft Corporation. Mac and the Mac logo are trademarks of Apple Computer, Inc, registered in the U.S. and other countries. All other trademarks or registered trademarks are the property of their respective holders.

Printed on 50% recycled paper including 20% post-consumer fibers.

Mitsubishi Digital Electronics America, Inc.  
Presentation Products Division  
9351 Jeronimo Road  
Irvine, CA 92618  
Toll Free: 888-307-0349  
email: ppinfo@mdea.me.com  
www.mitsubishi-presentations.com

**Technical Support:**  
Toll Free: 888-307-0309  
Email: tsupport@mdea.me.com  
  
**Canada:**  
Mitsubishi Electric Sales Canada Inc.  
Information Technologies Group  
Markham, Ontario  
905-475-7728  
www.mitsubishielectric.ca

