

SPLIT-TYPE AIR CONDITIONERS

**INDOOR UNIT**  
**MSY-GA24NA**



**OPERATING INSTRUCTIONS**

For user

- To use this unit correctly and safely, be sure to read these operating instructions before use.

**English**

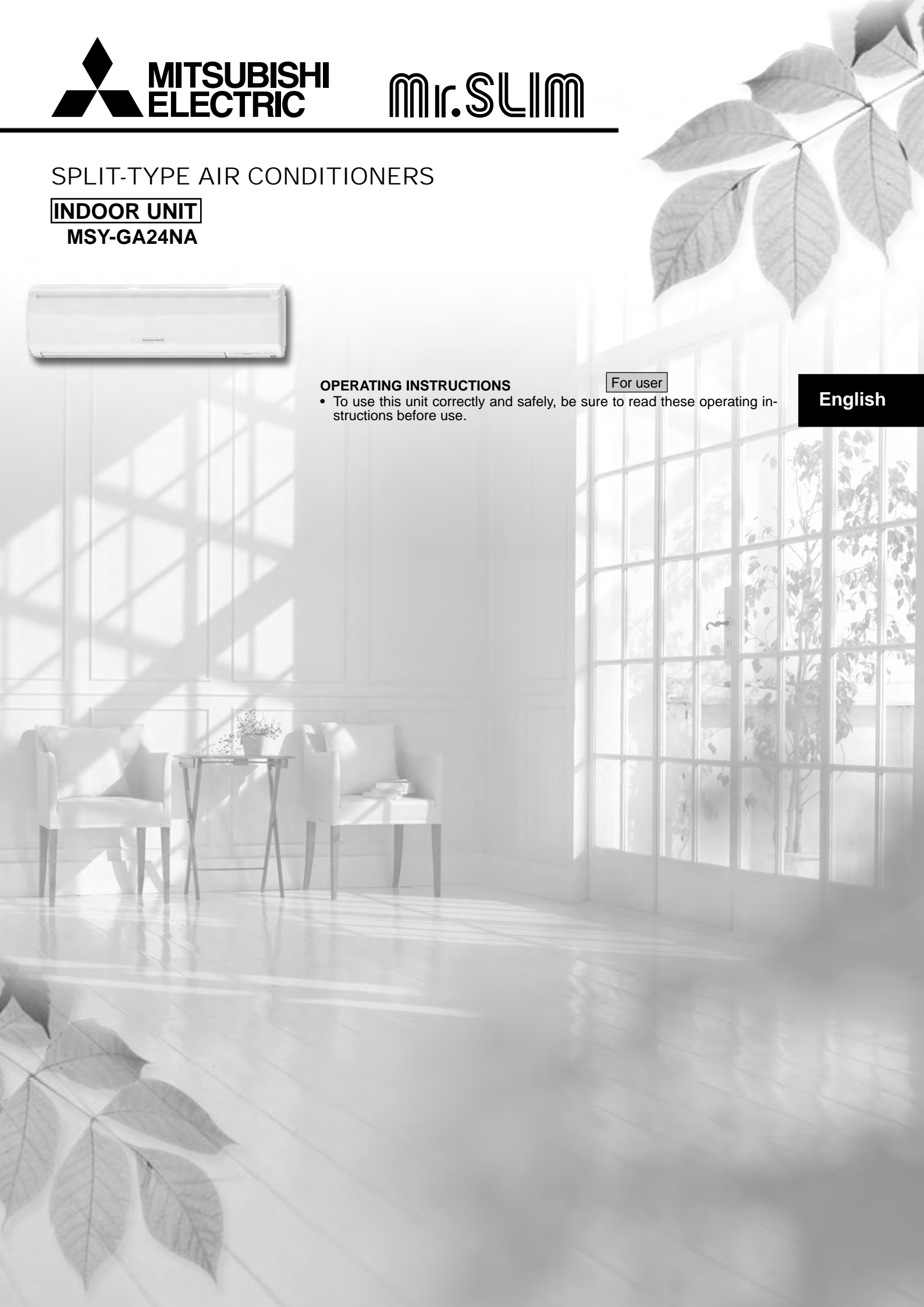



# CONTENTS

■ SAFETY PRECAUTIONS	1
■ NAME OF EACH PART	3
■ PREPARATION BEFORE OPERATION	4
■ SELECTING OPERATION MODES	5
■ FAN SPEED AND AIRFLOW DIRECTION ADJUSTMENT	6
■ ECONO COOL OPERATION	7
■ POWERFUL OPERATION	7
■ TIMER OPERATION (ON/OFF TIMER)	7
■ CLEANING	8
■ WHEN YOU THINK THAT TROUBLE HAS OCCURRED	9
■ WHEN THE AIR CONDITIONER IS NOT GOING TO BE USED FOR A LONG TIME	10
■ INSTALLATION PLACE AND ELECTRICAL WORK	10
■ SPECIFICATIONS	10







## SAFETY PRECAUTIONS





- Since rotating parts and parts which could cause an electric shock are used in this product, be sure to read these "Safety Precautions" before use.
- Since the cautionary items shown here are important for safety, be sure to observe them.
- After reading this manual, keep it together with the installation manual in a handy place for easy reference.
- Be sure to receive a guarantee card from your dealer and check that the purchased date and shop name, etc. are entered correctly.





### Marks and their meanings

-  **WARNING :** Incorrect handling could cause serious hazard, such as death, serious injury, etc. with a high probability.
-  **CAUTION :** Incorrect handling could cause serious hazard depending on the conditions.



### Meanings of symbols used in this manual



-  : Be sure not to do.
-  : Be sure to follow the instruction.
-  : Never insert your finger or stick, etc.
-  : Never step onto the indoor/outdoor unit and do not put anything on them.
-  : Danger of electric shock. Be careful.
-  : Be sure to disconnect the power supply plug from the power outlet.
-  : Be sure to shut off the power.

 <b>WARNING</b>	
	<p><b>Do not connect the power cord to an intermediate point, use an extension cord, or connect multiple devices to a single AC outlet.</b></p> <ul style="list-style-type: none"> <li>• This may cause overheating, fire, or electric shock.</li> </ul> <p><b>Make sure the power plug is free of dirt and insert it securely into the outlet.</b></p> <ul style="list-style-type: none"> <li>• A dirty plug may cause fire or electric shock.</li> </ul> <p><b>Do not bundle, pull, or modify the power cord, and do not apply heat or place heavy objects on it.</b></p> <ul style="list-style-type: none"> <li>• This may cause fire or electric shock.</li> </ul> <p><b>Do not turn the breaker OFF/ON or disconnect/connect the power plug during operation.</b></p> <ul style="list-style-type: none"> <li>• This may create sparks, which can cause fire.</li> <li>• After the indoor unit is switched OFF with the remote controller, make sure to turn the breaker OFF or disconnect the power plug.</li> </ul> <p><b>Do not expose your body directly to cool air for a prolonged length of time.</b></p> <ul style="list-style-type: none"> <li>• This could be detrimental to your health.</li> </ul> <p><b>The unit should not be installed, relocated, or repaired by the user.</b></p> <ul style="list-style-type: none"> <li>• An improperly handled air conditioner may cause fire or electric shock.</li> </ul>
 	<p><b>Do not insert your finger, a stick, or other objects into the air inlet or outlet.</b></p> <ul style="list-style-type: none"> <li>• This may cause injury, since the fan inside rotates at high speeds during operation.</li> </ul>

 	<p><b>In case of an abnormal condition (such as a burning smell), stop the air conditioner and disconnect the power plug or turn the breaker OFF.</b></p> <ul style="list-style-type: none"> <li>• A continued operation in the abnormal state may cause a malfunction, fire, or electric shock. In this case, consult your dealer.</li> </ul>
	<p><b>When the air conditioner does not cool or heat, there is a possibility of refrigerant leakage. In this case, consult your dealer. If a repair involves recharging the unit with refrigerant, ask the service technician for details.</b></p> <ul style="list-style-type: none"> <li>• The refrigerant used in the air conditioner is safe. Normally, it does not leak. However, if refrigerant leaks and comes in contact with a heat source such as a fan heater, kerosene heater, or cooking stove, it will create a harmful gas.</li> </ul>
 <b>CAUTION</b>	
	<p><b>Do not touch the air inlet or the aluminum fins of the indoor/outdoor unit.</b></p> <ul style="list-style-type: none"> <li>• This may cause injury.</li> </ul> <p><b>Do not use insecticides or flammable sprays on the unit.</b></p> <ul style="list-style-type: none"> <li>• This may cause a fire or deformation of the unit.</li> </ul> <p><b>Do not expose pets or houseplants to direct airflow.</b></p> <ul style="list-style-type: none"> <li>• This may cause injury to the pets or plants.</li> </ul> <p><b>Do not place other electric appliances or furniture under the indoor/outdoor unit.</b></p> <ul style="list-style-type: none"> <li>• Water may drip down from the unit, which may cause damage or malfunction.</li> </ul> <p><b>Do not leave the unit on a damaged installation stand.</b></p> <ul style="list-style-type: none"> <li>• The unit may fall and cause injury.</li> </ul>

# SAFETY PRECAUTIONS

 <b>CAUTION</b>	
	<p><b>Do not step on an unstable bench to operate or clean the unit.</b></p> <ul style="list-style-type: none"> <li>This may cause injury if you fall down.</li> </ul>
	<p><b>Do not pull the power cord.</b></p> <ul style="list-style-type: none"> <li>This may cause a portion of the core wire to break, which may cause overheating or fire.</li> </ul>
	<p><b>Do not charge or disassemble the batteries, and do not throw them into a fire.</b></p> <ul style="list-style-type: none"> <li>This may cause the batteries to leak, or cause a fire or explosion.</li> </ul>
	<p><b>Do not operate the unit for more than 4 hours at high humidity (80% RH or more) and/or with windows or outside door left open.</b></p> <ul style="list-style-type: none"> <li>This may cause the water condensation in the air conditioner, which may drip down, wetting or damaging the furniture.</li> <li>The water condensation in the air conditioner may contribute to growth of fungi, such as mold.</li> </ul>
	<p><b>Do not use the unit for special purposes, such as storing food, raising animals, growing plants, or preserving precision devices or art objects.</b></p> <ul style="list-style-type: none"> <li>This may cause deterioration of quality, or harm to animals and plants.</li> </ul>
	<p><b>Do not expose combustion appliances to direct airflow.</b></p> <ul style="list-style-type: none"> <li>This may cause incomplete combustion.</li> </ul>
	<p><b>Before cleaning the unit, switch it OFF and disconnect the power plug or turn the breaker OFF.</b></p> <ul style="list-style-type: none"> <li>This may cause injury, since the fan inside rotates at high speeds during operation.</li> </ul>
	<p><b>When the unit will be unused for a long time, disconnect the power plug or turn the breaker OFF.</b></p> <ul style="list-style-type: none"> <li>The unit may accumulate dirt, which may cause overheating or fire.</li> </ul>
	<p><b>Replace all batteries of the remote controller with new ones of the same type.</b></p> <ul style="list-style-type: none"> <li>Using an old battery together with a new one may cause overheating, leakage, or explosion.</li> </ul>
	<p><b>If the battery fluid comes in contact with your skin or clothes, wash them thoroughly with clean water.</b></p> <ul style="list-style-type: none"> <li>If the battery fluid comes in contact with your eyes, wash them thoroughly with clean water and immediately seek medical attention.</li> </ul>
	<p><b>Ensure that the area is well-ventilated when the unit is operated together with a combustion appliance.</b></p> <ul style="list-style-type: none"> <li>Inadequate ventilation may cause oxygen starvation.</li> </ul>
	<p><b>Turn the breaker OFF when you hear thunder and there is a possibility of a lightning strike.</b></p> <ul style="list-style-type: none"> <li>The unit may be damaged if lightning strikes.</li> </ul>
	<p><b>After the air conditioner is used for several seasons, perform inspection and maintenance in addition to normal cleaning.</b></p> <ul style="list-style-type: none"> <li>Dirt or dust in the unit may create an unpleasant odor, contribute to growth of fungi, such as mold, or clog the drain passage, and cause water to leak from the indoor unit. Consult your dealer for inspection and maintenance, which require specialized knowledge and skills.</li> </ul>





	<p><b>Do not operate switches with wet hands.</b></p> <ul style="list-style-type: none"> <li>This may cause electric shock.</li> </ul>
	<p><b>Do not clean the air conditioner with water or place an object that contains water, such as a flower vase, on it.</b></p> <ul style="list-style-type: none"> <li>This may cause fire or electric shock.</li> </ul>
	<p><b>Do not step on or place any object on the outdoor unit.</b></p> <ul style="list-style-type: none"> <li>This may cause injury if you or the object falls down.</li> </ul>

## IMPORTANT

**Dirty filters cause condensation in the air conditioner which will contribute to the growth of fungi such as mold. It is therefore recommended to clean air filters every 2 weeks.**

## For installation

### WARNING

	<p><b>Consult your dealer for installing the air conditioner.</b></p> <ul style="list-style-type: none"> <li>It should not be installed by the user since installation requires specialized knowledge and skills. An improperly installed air conditioner may cause water leakage, fire, or electric shock.</li> </ul>
	<p><b>Provide a dedicated power supply for the air conditioner.</b></p> <ul style="list-style-type: none"> <li>A non-dedicated power supply may cause overheating or fire.</li> </ul>
	<p><b>Do not install the unit where flammable gas could leak.</b></p> <ul style="list-style-type: none"> <li>If gas leaks and accumulates around the unit, it may cause an explosion.</li> </ul>
	<p><b>Ground the unit correctly.</b></p> <ul style="list-style-type: none"> <li>Do not connect the ground wire to a gas pipe, water pipe, lightning rod, or a telephone ground wire. Improper grounding may cause electric shock.</li> </ul>
 CAUTION	
	<p><b>Install a Ground Fault Interrupt (GFI) circuit breaker depending on the installation location of the air conditioner (such as highly humid areas).</b></p> <ul style="list-style-type: none"> <li>If the Ground Fault Interrupt (GFI) breaker is not installed, it may cause electric shock.</li> </ul>
	<p><b>Ensure that the drain water is properly drained.</b></p> <ul style="list-style-type: none"> <li>If the drain passage is improper, water may drip down from the indoor/outdoor unit, wetting and damaging the furniture.</li> </ul>

**In case of an abnormal condition**  
Immediately stop operating the air conditioner and consult your dealer.

# NAME OF EACH PART

## Indoor unit

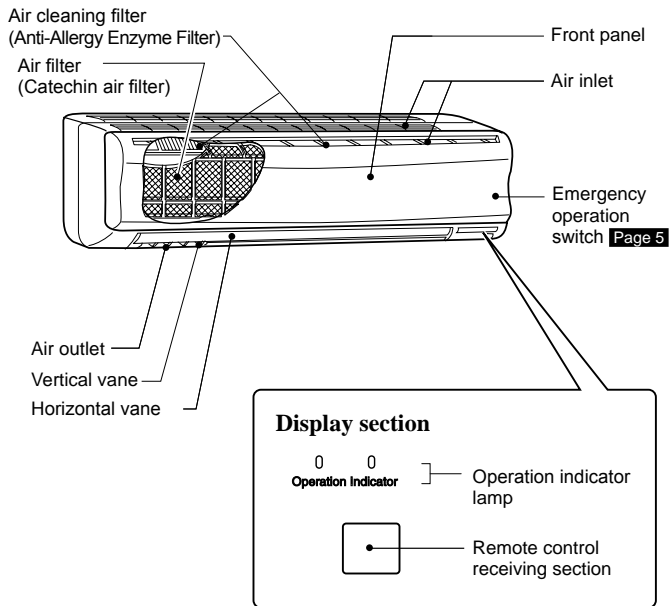

## Outdoor unit

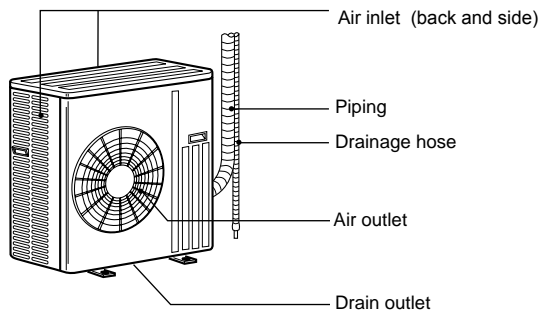

Outdoor units may be different in appearance.

## Remote controller

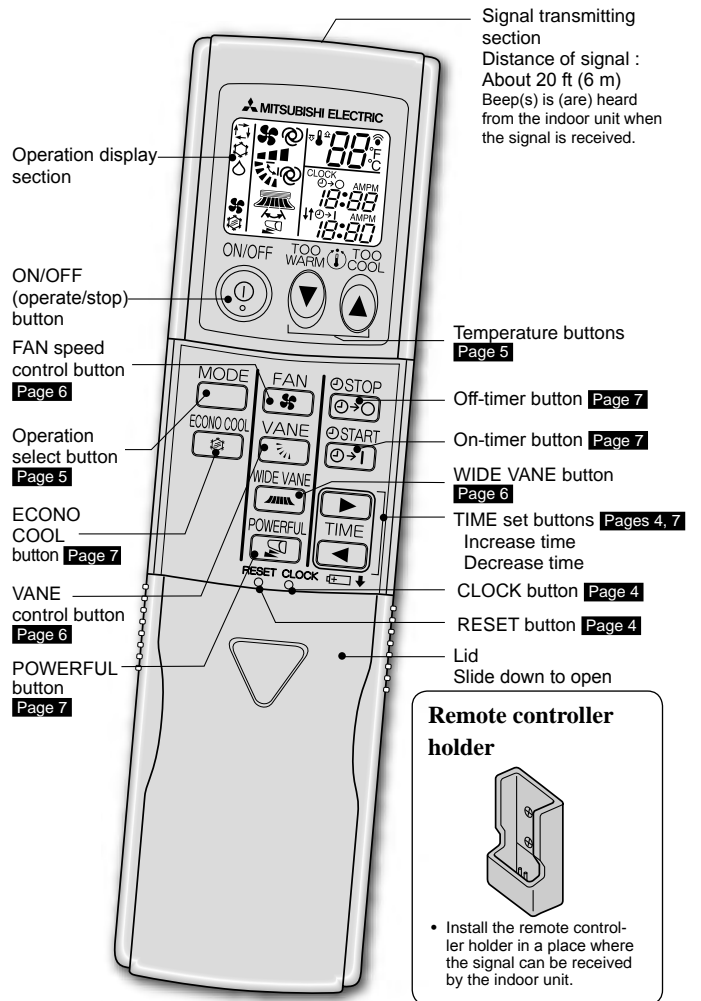

Only use the remote controller provided with the unit.  
 Do not use other remote controllers.

# PREPARATION BEFORE OPERATION

**Before operation:** Insert the power supply plug into the power outlet and/or turn the breaker on.

## Installing the remote controller batteries

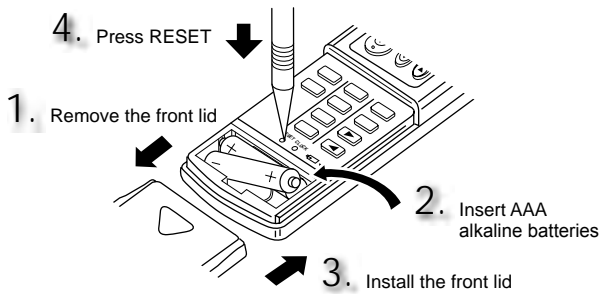

- Make sure the polarity of the batteries is correct.
- Do not use manganese batteries. The remote controller could malfunction.
- Do not use rechargeable batteries.
- Replace all batteries with new ones of the same type.
- Batteries can be used for approximately 1 year. However, batteries with expired shelf lives last shorter.
- Press RESET gently using a thin instrument.  
If the RESET button is not pressed, the remote controller may not operate correctly.

## Setting current time

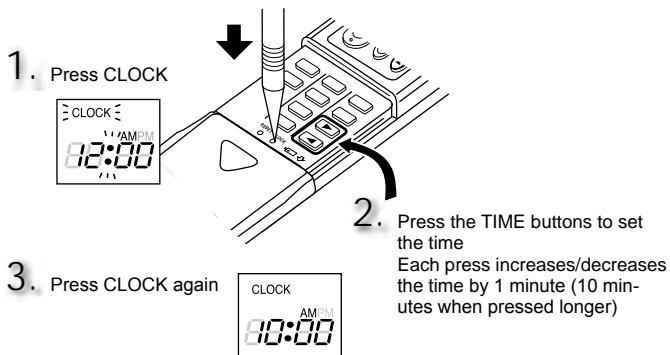

- Press CLOCK gently using a thin instrument.

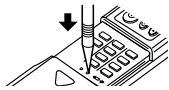

## Changing temperature units (°F→°C)

Unit is preset with °F.

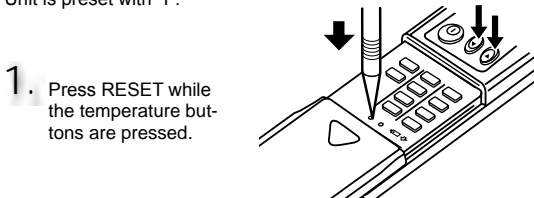

- Press RESET gently using a thin instrument.
- To change temperature unit from °C to °F, press RESET.

# SELECTING OPERATION MODES

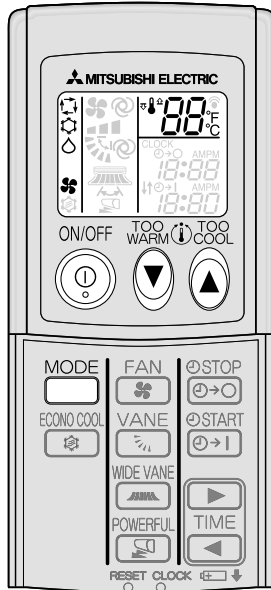

**1** Press to start the operation.

**2** Press to select operation mode. Each press changes mode in the following order:

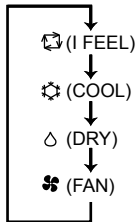

**3** Press or to set the temperature. Each press raises or lowers the temperature by 1°F (1°C).

Press to stop the operation.  
 • The same setting is selected the next time by simply pressing .

## Operation indicator lamp

The operation indicator lamp shows the operation state of the unit.

Indication	Operation state	Room temperature
	The unit is operating to reach the set temperature	About 4°F (2°C) or more away from set temperature
	The room temperature is approaching the set temperature	About 2 to 4°F (1 to 2°C) from set temperature

Lighted    Not lighted

## I FEEL mode

The unit selects the operation mode according to the room temperature when I FEEL is selected. When the room temperature is higher than 77°F (25°C), COOL is selected (set temperature: 75°F [24°C]). When the room temperature is lower than 77°F (25°C), DRY is selected. However, when operation is stopped and then started within 2 hours, the mode which has been selected previously is operated.

Note:

During COOL operation, the set temperature may not be changed when the room temperature is more than 4°F (2°C) higher than the set temperature. In this case, please wait until the room temperature drops to within 4°F (2°C) of the set temperature.

## COOL mode

Enjoy cool air at your desired temperature.  
 Do not operate COOL mode at very low outside temperatures. (less than 14°F [-10°C])  
 Water condensed in the unit may drip and wet or damage furniture, etc.

## DRY mode

Dehumidify your room. The room may be cooled slightly.  
 Temperature cannot be set during DRY mode.

## FAN mode

Circulate the air in your room.

## Emergency operation

### When the remote controller cannot be used...

Emergency operation can be activated by pressing the emergency operation switch (E.O.SW) on the indoor unit.

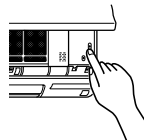

Each time the E.O.SW is pressed, the operation changes in the following order:

#### Operation indicator lamp

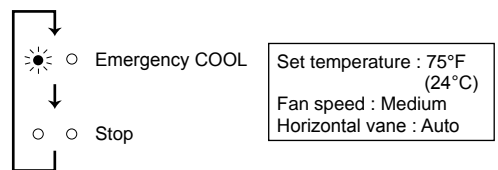

Set temperature : 75°F (24°C)  
 Fan speed : Medium  
 Horizontal vane : Auto

Note:

The first 30 minutes of operation is test run. Temperature control does not work, and fan speed is set to High.

## Auto restart function

If a power failure occurs or the main power is turned off during operation, "Auto restart function" automatically starts operation in the same mode as the one set with the remote controller just before the shutoff of the main power. When timer is set, timer setting is cancelled and the unit starts operation when power is resumed.

If you do not want to use this function, please consult the service representative because the setting of the unit needs to be changed.

# FAN SPEED AND AIRFLOW DIRECTION ADJUSTMENT

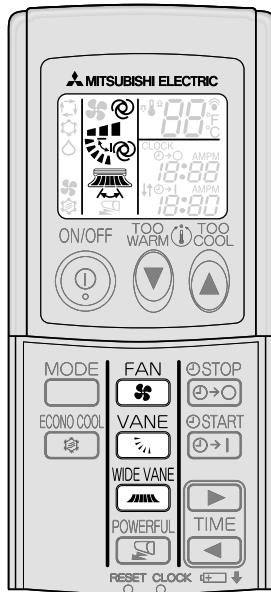

## Vertical airflow direction

### ⊗ (AUTO)

The vane is set to the most efficient airflow direction: horizontal position.

### ▲ (Manual)

For efficient air conditioning, select upper position for COOL/DRY. During COOL/DRY, when the vane is set to position (4) or (5), the vane automatically moves to horizontal position after 0.5 to 1 hour to prevent any condensation from dripping.

### ↕ (Swing)

The vane moves up and down intermittently.

Press **FAN**  to select fan speed. Each press changes fan speed in the following order:

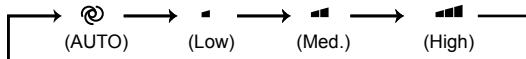

• Two short beeps are heard from the indoor unit when set to AUTO.

Press **VANE**  to select airflow direction. Each press changes airflow direction in the following order:

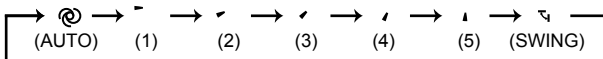

• Two short beeps are heard from the indoor unit when set to AUTO.

Press **WIDE VANE**  to select horizontal airflow direction. Each press changes airflow direction in the following order:



# ECONO COOL OPERATION

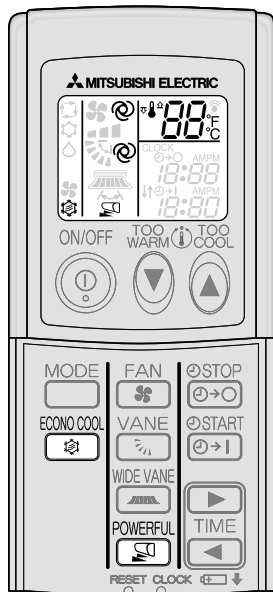

**ECONO COOL**  
 Press during COOL mode **page 5** to start ECONO COOL operation.  
 The unit performs swing operation vertically in various cycle according to the temperature of the unit. Set temperature is set 4°F (2°C) higher automatically.

**ECONO COOL**  
 Press again to cancel ECONO COOL operation.  
 • ECONO COOL operation also is cancelled when the VANE or POWERFUL button is pressed.

**What is "ECONO COOL"?**  
 Swing air flow (change of air flow) makes you feel cooler than constant air flow. So, even though the set temperature is automatically set 4°F (2°C) higher, it is possible to perform cooling operation with keeping comfort. As a result, energy can be saved.

# POWERFUL OPERATION

**POWERFUL**  
 Press during COOL mode **page 5** to start POWERFUL operation.

Fan speed : Exclusive speed for POWERFUL mode  
 Horizontal vane : Set position, or downward airflow position during AUTO setting

• Temperature cannot be set during POWERFUL operation.

**POWERFUL**  
 Press again to cancel POWERFUL operation.  
 • POWERFUL operation also is cancelled automatically in 15 minutes, or when the ON/OFF, FAN, or ECONO COOL button is pressed.

# TIMER OPERATION (ON/OFF TIMER)

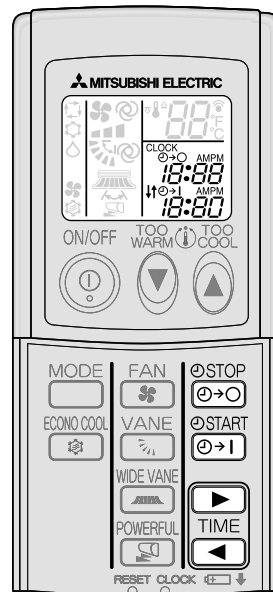

**1** Press or during operation to set the timer.  
 (ON timer) : The unit will turn ON at the set time.  
 (OFF timer) : The unit will turn OFF at the set time.  
 \* or blinks.  
 \* **Make sure that the current time is set correctly.** **Page 4**

**2** Press (Increase) and (Decrease) to set the time of timer.  
 Each press increases or decreases the set time by 10 minutes.

Press or again to cancel timer.

**Note:**  
 • ON and OFF timers can be set together. mark indicates the order of timer operations.  
 • If power failure occurs while ON/OFF timer is set, see **page 5** "Auto restart function"

# CLEANING

## Instructions:

- Switch off the power supply or turn off the breaker before cleaning.
- Be careful not to touch the metal parts with your hands.
- Do not use benzene, thinner, polishing powder, or insecticide.
- Use only diluted mild detergents.
- Do not expose parts to direct sunlight, heat, or fire to dry.
- Do not use water hotter than 120°F (50°C).

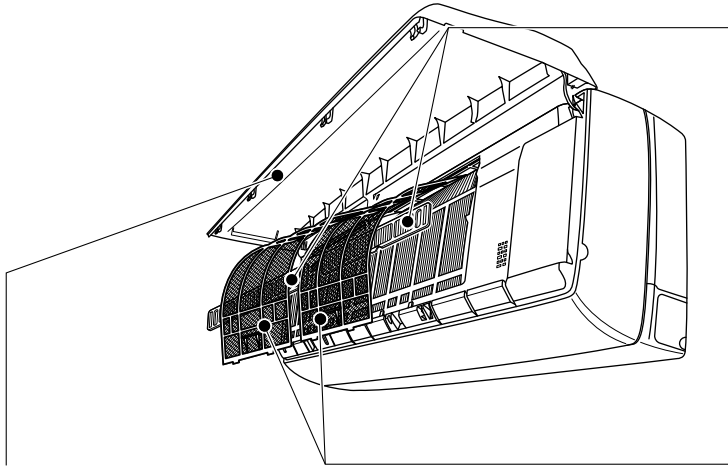

## Front panel

Do not open the front panel up past the level position.

- The panel may come off in order to prevent it from being damaged.
- The panel may also come off if the upper part of the panel is pulled down.

If the front panel comes off, attach it as explained below.

1. Keep the front panel level with one hand, and insert the hinges one by one with the other hand into the notches at the left, right, and center of the top of the indoor unit until they click into place.
2. Close the front panel.

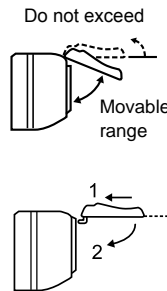

## Air cleaning filter (Anti-Allergy Enzyme Filter)

### Back side of air filter

Clean every 3 months:

- Remove dirt by a vacuum cleaner.
- Put it back to its original position.

When dirt cannot be removed by vacuum cleaning:

- Soak the filter and its frame in lukewarm water before rinsing it. (Diluted mild detergents can be used when dirt cannot be removed.)
- After washing with water, dry it well in shade. Install all tabs of the air filter.

Every year:

- Replace it with a new air cleaning filter for best performance.
- Parts Number **MAC-2300FT**

## Air filter (Catechin air filter)

- **Clean every 2 weeks**
- Remove dirt by a vacuum cleaner, or wash with water.
- After washing with water, dry it well in shade.

## What is "Catechin air filter" ?

Catechin is a bioflavonoid that is found in green tea that has both antiviral and antioxidant qualities. In addition to these benefits, Catechin also offers excellent deodorizing characteristics. Catechin air filter uses this compound to not only improve air quality but also prevent the spread of bacteria and viruses in the room.



### Important

- **Clean the filters regularly for best performance and to reduce power consumption.**
- **Dirty filters cause condensation in the air conditioner which will contribute to the growth of fungi such as mold. It is therefore recommended to clean air filters every 2 weeks.**

# WHEN YOU THINK THAT TROUBLE HAS OCCURRED

Even if these items are checked, when the unit does not recover from the trouble, stop using the air conditioner and consult your dealer.

Symptom	Explanation & Check points
<b>Indoor Unit</b>	
The unit cannot be operated.	<ul style="list-style-type: none"> <li>Is the breaker turned on?</li> <li>Is the power supply plug connected?</li> <li>Is the ON timer set? <b>Page 7</b></li> </ul>
The unit cannot be operated for about 3 minutes when restarted.	<ul style="list-style-type: none"> <li>This protects the unit according to instructions from the microprocessor. Please wait.</li> </ul>
Mist is discharged from the air outlet of the indoor unit.	<ul style="list-style-type: none"> <li>The cool air from the unit rapidly cools moisture in the air inside the room, and it turns into mist.</li> </ul>
The swing operation of the HORIZONTAL / VERTICAL VANE is suspended for a while, then restarted.	<ul style="list-style-type: none"> <li>This is for the swing operation of the HORIZONTAL / VERTICAL VANE to be performed normally.</li> </ul>
The air flow direction changes during operation. The direction of the horizontal vane cannot be adjusted with the remote controller.	<ul style="list-style-type: none"> <li>When the unit is operated in COOL or DRY mode, if the operation continues with air blowing down for 0.5 to 1 hour, the direction of the air flow is automatically set to horizontal position to prevent water from condensing and dripping.</li> </ul>
The unit starts operation by itself when the main power is turned on, though it isn't operated with the remote controller.	<ul style="list-style-type: none"> <li>These models are equipped with an auto restart function. When the main power is turned off without stopping the unit with the remote controller and is turned on again, the unit starts operation automatically in the same mode as the one set with the remote controller just before the shutoff of the main power. Refer to "Auto restart function" <b>page 5</b>.</li> </ul>
<b>Outdoor Unit</b>	
The fan of the outdoor unit does not rotate even though the compressor is running. Even if the fan starts to rotate, it stops soon.	<ul style="list-style-type: none"> <li>When the outside temperature is low during cooling operation, the fan operates intermittently to maintain sufficient cooling capacity.</li> </ul>
Water leaks from the outdoor unit.	<ul style="list-style-type: none"> <li>During COOL and DRY operations, pipe or pipe connecting sections are cooled and this causes water to condense.</li> </ul>
<b>Remote controller</b>	
The display on the remote controller does not appear or it is dim. The indoor unit does not respond to the remote control signal.	<ul style="list-style-type: none"> <li>Are the batteries exhausted? <b>Page 4</b></li> <li>Is the polarity (+, -) of the batteries correct? <b>Page 4</b></li> <li>Are any buttons on the remote controller of other electric appliances being pressed?</li> </ul>
<b>Does not cool</b>	
The room cannot be cooled sufficiently.	<ul style="list-style-type: none"> <li>Is the temperature setting appropriate? <b>Page 5</b></li> <li>Is the fan setting appropriate? Please change fan speed to higher setting. <b>Page 6</b></li> <li>Are the filters clean? <b>Page 8</b></li> <li>Is the fan or heat exchanger of the indoor unit clean?</li> <li>Are there any obstacles blocking the air inlet or outlet of the indoor or outdoor unit?</li> <li>Is a window or door open?</li> <li>When a ventilation fan or a gas cooker is used in a room, the cooling load increases, resulting in an insufficient cooling effect.</li> <li>When the outside temperature is high, the cooling effect may not be sufficient.</li> </ul>

Symptom	Explanation & Check points
<b>Airflow</b>	
The air from the indoor unit smells strange.	<ul style="list-style-type: none"> <li>Are the filters clean? <b>Page 8</b></li> <li>Is the fan or heat exchanger of the indoor unit clean?</li> <li>The unit may suck in an odor adhering to the wall, carpet, furniture, cloth, etc. and blow it out with the air.</li> </ul>
<b>Sound</b>	
Cracking sound is heard.	<ul style="list-style-type: none"> <li>This sound is generated by the expansion/contraction of the front panel, etc. due to change in temperature.</li> </ul>
"Bubbling" sound is heard.	<ul style="list-style-type: none"> <li>This sound is heard when the outside air is absorbed from the drain hose by turning on the range hood or the ventilation fan, making water flowing in the drain hose to spout out. This sound is also heard when the outside air blows into the drain hose in case the outside wind is strong.</li> </ul>
Mechanical sound is heard from the indoor unit.	<ul style="list-style-type: none"> <li>This is the switching sound in turning on/off the fan or the compressor.</li> </ul>
The sound of water flowing is heard.	<ul style="list-style-type: none"> <li>This is the sound of refrigerant or condensed water flowing in the unit.</li> </ul>

In the following cases, stop using the air conditioner and consult your dealer.

- When water leaks or drips from the indoor unit.
- When the left operation indicator lamp blinks.
- When the breaker trips frequently.
- The remote control signal is not received in a room where an electronic ON/OFF type fluorescent lamp (inverter-type fluorescent lamp, etc.) is used.
- Operation of the air conditioner interferes with radio or TV reception. An amplifier may be required for the affected device.
- When an abnormal sound is heard.

## WHEN THE AIR CONDITIONER IS NOT GOING TO BE USED FOR A LONG TIME

- 1 Set to the highest temperature in manual COOL mode, and operate for 3 to 4 hours. **Page 5**
  - This dries the inside of the unit.
  - Moisture in the air conditioner contributes to favorable conditions for growth of fungi, such as mold.
- 2 Press  to stop the operation.
- 3 Turn off the breaker and/or disconnect the power supply plug.
- 4 Remove all batteries from the remote controller.

## When using the air conditioner again:

- 1 Clean the air filters. **Page 8**
- 2 Check that the air inlet and outlet of the indoor and outdoor units are not blocked.
- 3 Check that the ground wire is connected correctly.

## INSTALLATION PLACE AND ELECTRICAL WORK

### Installation place

Avoid installing the air conditioner in the following places.

- Where there is much machine oil.
- Salty places such as the seaside.
- Where sulfide gas is generated such as a hot spring.
- Where oil is splashed or where the area is filled with oily smoke.
- Where there is high-frequency or wireless equipment.
- Where the air from the outdoor unit air outlet is blocked.
- Where the operation sound or air from the outdoor unit does not bother the house next door.

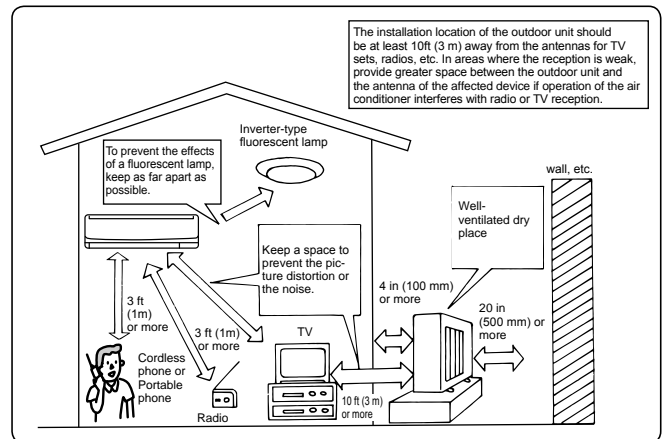

### Electrical work

- Provide an exclusive circuit for the power supply of the air conditioner.
- Be sure to observe the breaker capacity.

If you have any questions, consult your dealer.

## SPECIFICATIONS

### Guaranteed operating range

		Indoor	Outdoor
Cooling	Upper limit	90°F (32.2°C) DB	115°F (46.1°C) DB
		73°F (22.8°C) WB	—
	Lower limit	67°F (19.4°C) DB	14°F (-10°C) DB
		57°F (13.9°C) WB	—

DB : Dry Bulb  
WB : Wet Bulb



---

HEAD OFFICE: TOKYO BLDG., 2-7-3, MARUNOUCHI, CHIYODA-KU, TOKYO 100-8310, JAPAN

JG79A168H01